

Cooker
Elektroherde

CSM 67300 G

BEKO

Please read this manual first.

Dear Customer,

We would like you to obtain best performance with your product that has been manufactured in modern facilities and passed through strict quality control procedures.

Therefore, we advise you to read through this User Manual carefully before using your product and keep it for future reference. If you hand over the product to someone else, deliver the User Manual as well.

The User Manual will help you use the product in a fast and safe way.

- Read the User Manual before installing and starting the product.
- You must strictly observe the safety instructions.
- Keep this User Manual within easy reach for future reference.
- Also read other documents supplied with the product.
Remember that this User Manual may also be applicable for several other models.
Differences between models are explicitly identified in the manual.

Explanation of symbols

Throughout this User Manual the following symbols are used:

 Important information or useful hints about usage.

 Warning for hazardous situations with regard to life and property.

 Warning for electric shock.

 Warning for risk of fire.

 Warning for hot surfaces.



Arçelik A.Ş.

Karaağaç caddesi No:2-6
34445 Sütlüce/İstanbul/TURKEY

Made in TURKEY

Table of Contents

1	General information	4
	Overview	4
	Technical specifications	5
	Accessories	6
2	Safety instructions	7
	General safety.....	7
	Safety when working with electricity .	8
	Intended use	8
	Safety for children	8
3	Installation	9
	Before installation	9
	Installation and connection.....	9
	Disposal	11
	Disposing of packaging material	11
	Disposing of the old product.....	11
	Future Transportation.....	11
4	Preparation	13
	Tips for saving energy	13
	Initial operation	13
	Setting the time	13
	First cleaning of the appliance	14
	Initial heating	14
5	How to use the hob	16
	General information on cooking.....	16
	How to use hobs.....	16
6	How to operate the oven	18
	General information on baking, roasting and grilling	18
	How to use the electric oven	18
	Operating modes.....	19
	How to operate the oven timer.....	20
	How to use the program lock	22
	How to use the alarm clock.....	22
	Cooking times table.....	23
	How to operate the grill	25
	Cooking times table for grilling.....	25
7	Maintenance and care	26
	General information	26
	Cleaning the hob.....	26
	Cleaning the control panel	27
	Cleaning the oven	27
	Removal of oven door.....	27
	Replacing the oven lamp	28
8	Troubleshooting	29

1 General information

Overview

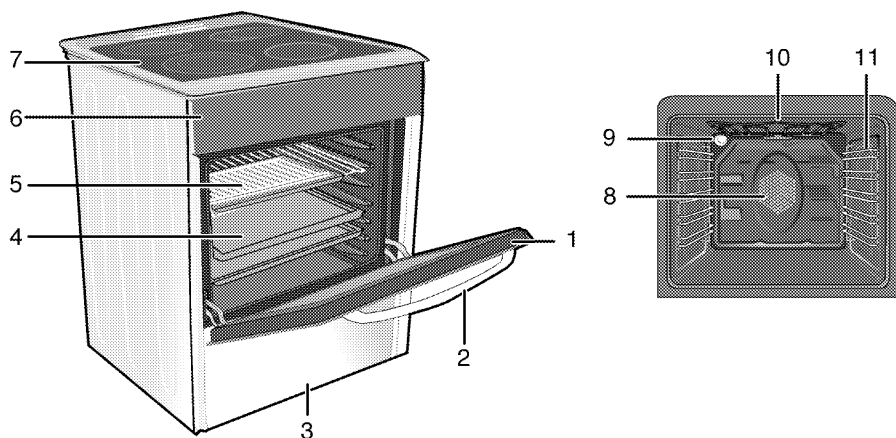

- 1 Front door
- 2 Handle
- 3 Bottom drawer
- 4 Tray
- 5 Wire shelf
- 6 Control panel

- 7 Burners' plate
- 8 Fan motor (behind steel plate)
- 9 Lamp
- 10 Grill heating element
- 11 Shelf positions

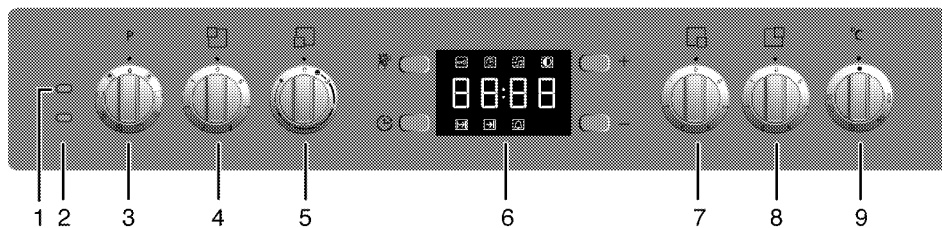

- 1 Warning lamp
- 2 Thermostat lamp
- 3 Function knob
- 4 Single-circuit cooking plate Rear left
- 5 Dual-circuit cooking plate Front left
- 6 Digital timer

- 7 Single-circuit cooking plate Front right
- 8 Single-circuit cooking plate Rear right
- 9 Thermostat knob

Technical specifications

GENERAL	
External dimensions (height / width / depth)	850 mm/600 mm/600 mm
Voltage / frequency	220-240 V/380-415 3N V ~ 50 Hz
Total power consumption	9.1 kW
Fuse	min. 16 A x 3
Cable type / section	H05VV-FG 5 x 1,5 mm ² / 3 x 2,5 mm ²
Cable length	max. 2 m
HOB	
Burners	
Rear left	Single-circuit cooking plate
Dimension	160 mm
Power	1500 W
Front left	Dual-circuit cooking plate
Dimension	210/120 mm
Power	2200/750 W
Front right	Single-circuit cooking plate
Dimension	140 mm
Power	1200 W
Rear right	Single-circuit cooking plate
Dimension	180mm
Power	1800 W
OVEN/GRILL	
Main oven	Multifunction oven
Energy efficiency class [#]	A
Inner lamp	15–25 W
Grill power consumption	2.2 kW

[#] Basics: Information on the energy label of electrical ovens is given in accordance with the EN 50304 standard. Those values are determined under standard load with bottom-top heater or fan assisted heating (if any) functions.

Energy efficiency class is determined in accordance with the following prioritization depending on whether the relevant functions exist on the product or not. 1-Cooking with eco-fan, 2- Turbo slow cooking, 3- Turbo cooking, 4- Fan assisted bottom/top heating, 5-Top and bottom heating.

** See. *Installation*, page 9.

 Technical specifications may be changed without prior notice to improve the quality of the product.

 Figures in this manual are schematic and may not exactly match your product.

 Values stated on the product labels or in the documentation accompanying it are obtained in laboratory conditions in accordance with relevant standards. Depending on operational and environmental conditions of the product, these values may vary.

Accessories

 Accessories supplied can vary depending on the product model. Not every accessory described in the user manual may exist on your product.

Oven tray

Used for pastries, frozen foods and big roasts.

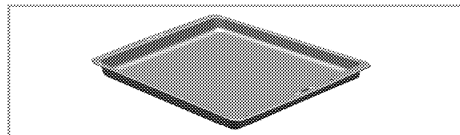

Deep tray

Used for pastries, large roasts, juicy dishes, and for collecting the fat while grilling.

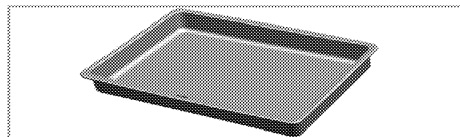

Aluminium cake tray

Used for pastries such as cookies and biscuits.

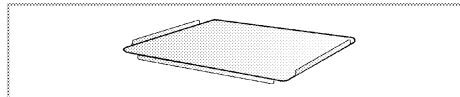

Cake tray

Used for pastries such as cookies and biscuits.

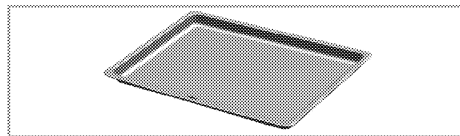

Small oven tray

Used for small portions. This oven tray is placed onto the wire grill.

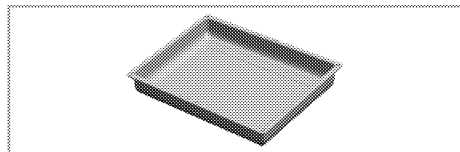

Wire grill

Used for roasting and for placing the food to be baked, roasted or cooked in casserole dishes to the desired rack.

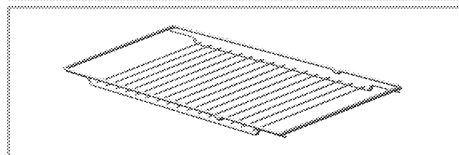
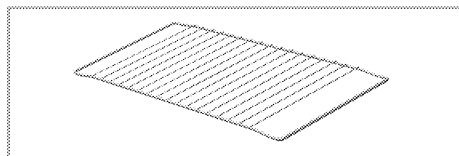

Placing the wire grill and tray onto the telescopic racks properly

Telescopic racks allow you to install and remove the trays and wire grill easily. When using the tray and wire grill with telescopic racks, make sure that the pins at the rear section of the telescopic rack stands against the edges of the wire grill and tray.

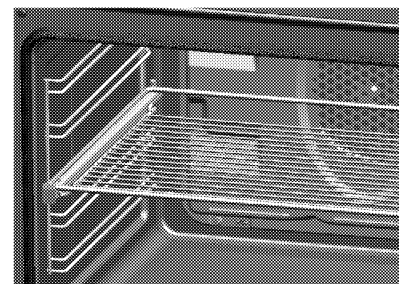
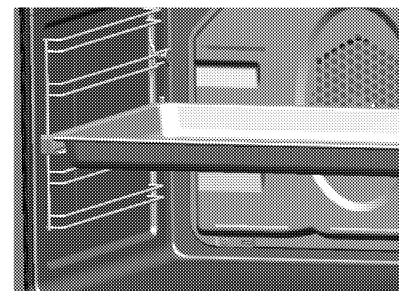

2 Safety instructions

General safety

- This product is not intended to be used by persons with physical, sensory or mental disorders or unlearned or inexperienced people (including children) unless they are attended by a person who will be responsible for their safety or who will instruct them accordingly for use of the product.
Children must be supervised to prevent them from tampering with the product.
- Connect the product to a grounded outlet/line protected by a fuse of suitable capacity as stated in the "Technical specifications" table. Have the grounding installation made by a qualified electrician while using the product with or without a transformer. Our company shall not be liable for any damages that will arise due to using the product without a grounding installation in accordance with the local regulations.
- Do not operate the product if the power cable or plug is damaged. Call Authorised Service Agent.
- Do not operate the product if it is defective or has any visible damage.
- Do not carry out any repairs or modifications on the product. However, you may remedy some troubles that do not require any repairs or modifications. See *Troubleshooting, page 29*.
- Never wash down the product with water! There is the risk of electric shock!
- Never use the product when your judgement or coordination is impaired by the use of alcohol and/or drugs.
- Product must be disconnected from the mains during installation, maintenance, cleaning and repair procedures.
- Installation and repair procedures must always be performed by Authorised Service Agents. Manufacturer shall not be held responsible for damages arising from procedures carried out by unauthorised persons and may void the warranty.
- Be careful when using alcoholic drinks in your dishes. Alcohol evaporates at high temperatures and may cause fire since it can ignite when it comes into contact with hot surfaces.
- Do not heat closed tins and glass jars in the oven. The pressure that would build-up in the jar may cause it to burst out.
- Do not place any flammable materials close to the product as the sides become hot during use.
- Do not place baking trays, dishes or aluminium foil directly onto the bottom of the oven. The heat accumulation might damage the bottom of the oven.
- Keep all ventilation slots clear of obstructions.
- Product may be hot when it is in use. Never touch the hot burners,

inner sections of the oven, heaters and etc.

- Always use heat resistant oven gloves when putting and removing dishes into/from the hot oven.
- Do not use the product with front door glass removed or cracked.
- Rear surface of the oven gets hot when it is in use. Make sure that the gas/electrical connection do not contact the rear surface; otherwise, connections can get damaged.
- Do not trap the mains cable between the oven door and frame and do not route it over the hot surfaces. Otherwise, cable insulation may melt and cause fire as a result of short circuit.
- Make sure that the product is switched off after every use.
- Vapour pressure that build up due to the moisture on the hob surface or at the bottom of the pot can cause the pot to hop. Therefore, make sure that the oven surface and bottom of the pots are always dry.

 Product must be installed by a qualified person in accordance with the regulations in force. Otherwise, the warranty shall become void.

Safety when working with electricity

- Any work on electric equipment and systems may only be carried out by authorized qualified persons.
- In case of any damage, switch off the appliance and disconnect it from the mains supply by removing the

fuse or switching off the circuit breaker.

- Ensure that the fuse rating is correct.

Intended use

This product is designed for domestic use. Commercial use is not admissible. "CAUTION: This appliance is for cooking purposes only. It must not be used for other purposes, for example room heating."

This product should not be used for warming the plates under the grill, drying towels, dish cloths and etc. by hanging them on the handles and for heating purposes.

The manufacturer shall not be liable for any damage caused by improper use or handling errors.

The oven can be used for defrosting, baking, roasting and grilling food.

Safety for children

- Accessible parts of the appliance will become hot whilst the appliance is in use and until the appliance has cooled, children should be kept away.
- "**CAUTION:** Accessible parts may be hot when the grill is in use. Young children should be kept away."
- Do not store any items above the appliance that children may reach.
- The packaging materials will be dangerous for children. Keep the packaging materials away from children. Please dispose of all parts of the packaging according to environmental standards.
- When the door is open, do **not** load any heavy object on it and do **not** allow children to sit on it. It may overturn or door hinges may get damaged.

3 Installation

Before installation

To ensure that critical air gaps are maintained under the appliance, we recommend that this appliance is mounted on a solid base and that the feet do not sink into any carpet or soft flooring.

The kitchen floor must be able to carry the weight of the appliance plus the additional weight of cookware and bakeware and food.

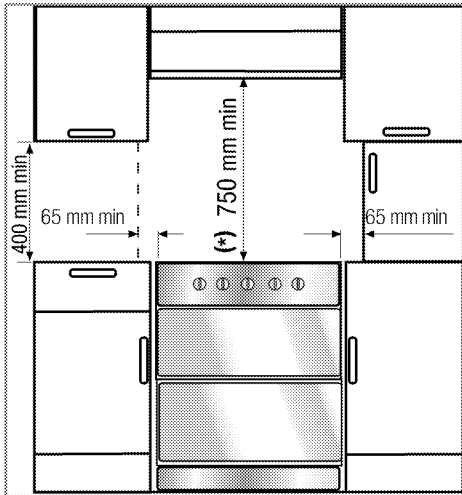

A safety distance must be left between the appliance and the kitchen walls and furniture. See figure (values in mm).

- It can be used with cabinets on either side but in order to have a minimum distance of 400 mm above hotplate level allow a side clearance of 65 mm between the appliance and any wall, partition or tall cupboard.
- It can also be used in a free standing position. Allow a minimum distance of 750 mm above the hob surface.

- (*) If a cooker hood is to be installed above the cooker, refer to cooker hood manufacturer's instructions regarding installation height (Min 65cm).
- The appliance corresponds to device class 1, i.e. it may be placed with the rear and **one** side to kitchen walls, kitchen furniture or equipment of any size. The kitchen furniture or equipment on the **other** side may only be of the same size or smaller.
- Any kitchen furniture next to the appliance must be heat-resistant (100 °C min.).

Installation and connection

- i** Do not install the appliance next to refrigerators or freezers. The heat emitted by the appliance will lead to an increased energy consumption of cooling appliances.
- Appliance to be installed in accordance with the local authority requirements for gas, electricity and any other authority having jurisdiction.
- Carry the appliance with at least two persons.
- i** **Material damage!**
The door and/or handle must not be used for lifting or moving the appliance.
- The appliance must be placed directly on the floor. It must not be placed onto a base or a pedestal.

-  Risk of explosion by damage of the safety tube!
The safety tube must not be clamped, bent or trapped or come into contact with hot parts of the appliance.

Connection to the mains supply

 **This appliance must be earthed!**

Our company shall not be held responsible for any damage caused by using the appliance without earthed socket.

-  Risk of electric shock, short circuit or fire by unprofessional installation!
The appliance may be connected to the mains supply only by an authorized qualified person and the appliance is only guaranteed after correct installation.

-  Risk of electric shock, short circuit or fire by damage of the mains lead!
The mains lead must not be clamped, bent or trapped or come into contact with hot parts of the appliance.
If the mains lead is damaged, it must be replaced by a qualified electrician.

The mains supply data must correspond to the data specified on the rating plate of the appliance. The rating plate is either seen when the door or the lower cover is opened or it is located at the rear wall of the appliance depending on the appliance type.

The supply cable of the appliance must correspond to the specifications;

see technical data table *Technical specifications*, page 5.

-  Risk of electric shock!
Before starting any work on the electrical installation, please disconnect the appliance from the mains supply.

1. A mains lead is not supplied with the appliance, It must connect a mains lead to your appliance that you would select from the table on basis of the installation at your home, following the instructions in the wiring diagram.

If no all-pole separation from the mains supply is possible, a separation appliance must be connected with a contact distance of 3 mm min. (fuses, line safety switches, contactors) all poles which should be adjacent to (but not above) the appliance in accordance with IEE regulation. Failure to observe this instruction may result in operational problems and invalidation of the appliance warranty. Additional protection by a residual current circuit breaker is recommended.

2. Open the terminal block cover with screwdriver.
3. Pass the mains lead through the cable clamp under the terminal and fix the mains lead to main body with supplied screw via cable tightener.
4. Connect the cables according to the supplied diagram.
5. Close the cover of the terminal block once the wiring is complete.

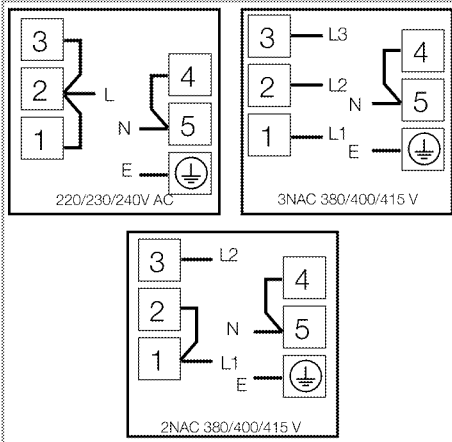

i Mains lead must not be longer than 2 metres for safety reasons.

6. The mains lead should be routed away from the appliance and not be trapped between the appliance and the wall.
 - Position appliance up to the kitchen wall.
 - To align the appliance with the worktop, adjust the feet turning right or left hand as required.

Final check

1. Switch electricity supply on.
2. Check electrical functions.

Disposal

Disposing of packaging material

Packaging materials are dangerous to children. Keep packaging materials in a safe place out of reach of children. Packaging materials of the product are manufactured from recyclable materials. Dispose of them properly and sort in accordance with recycled waste instructions. Do not dispose of them with normal domestic waste.

Disposing of the old product



Dispose of the old product in an environmentally friendly manner.

This equipment bears the selective sorting symbol for waste electrical and electronic equipment (WEEE). This means that this equipment must be handled pursuant to European Directive 2002/96/EC in order to be recycled or dismantled to minimize its impact on the environment. For further information, please contact local or regional authorities.

Electronic equipments not included in the selective sorting process are potentially dangerous for the environment and human health due to the presence of hazardous substances. Refer to your local dealer or solid waste collection centre in your area to learn how to dispose of your product. Before disposing of the product, cut off the power cable plug and make the door lock (if any) unusable to avoid dangerous conditions to children.

Future Transportation

- Keep the product's original carton and transport the product in it. Follow the instructions on the carton. If you do not have the original carton, pack the product in bubble wrap or thick cardboard and tape it securely.
- To prevent the wire grill and tray inside the oven from damaging the oven door, place a strip of cardboard onto the inside of the oven door that lines up with the

position of the trays. Tape the oven door to the side walls.

- Do not use the door or handle to lift or move the product.

 Do not place other items on the top of the appliance. The appliance must be transported upright.

 Check the general appearance of your product for any damages that might have occurred during transportation.

4 Preparation

Tips for saving energy

The following information will help you to use your appliance in an ecological way, and to save energy:

- Use dark coloured or enamel coated cookware in the oven since the heat transmission will be better.
- While cooking your dishes, perform a preheating operation if it is advised in the user manual or cooking instructions.
- Do not open the door of the oven frequently during cooking.
- Try to cook more than one dish in the oven at the same time whenever possible. You can cook by placing two cooking vessels onto the wire grill.
- Cook more than one dish one after another. The oven will already be hot.
- You can save energy by switching off your oven a few minutes before the end of the cooking time. Do not open the oven door.
- Defrost frozen dishes before cooking them.
- Use pots/pans with cover for cooking. If there is no cover, energy consumption may increase 4 times.
- Select the burner which is suitable for the bottom size of the pot to be used. Always select the correct pot size for your dishes. Larger pots require more energy.
- Pay attention to use flat bottom pots when cooking with electric hobs.



Pots with thick bottom will provide a better heat conduction. You can obtain energy savings up to 1/3.

- Vessels and pots must be compatible with the cooking zones. Bottom of the vessels or pots must not be smaller than the hotplate.
- Keep the cooking zones and bottom of the pots clean. Dirt will decrease the heat conduction between the cooking zone and bottom of the pot.
- For long cookings, turn off the cooking zone 5 or 10 minutes before the end of cooking time. You can obtain energy savings up to 20% by using the residual heat.

Initial operation

Before first usage of your appliance, don't forget to remove the sticker on the digital timer screen.

Setting the time

-  Before using the oven the clock time must be set. If the clock time is not set, the main oven will not work.
-  While making any adjustment, related symbols on the clock will flash.

After switching on the oven for the first time, adjust the current time with keys 5 and 6.

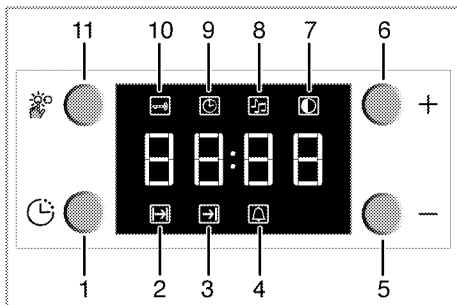

- 1 Program knob
- 2 Cooking time
- 3 Cooking end time
- 4 Alarm period
- 5 Minus key
- 6 Plus key
- 7 Screen brightness adjustment
- 8 Alarm volume
- 9 Current time
- 10 Keylock
- 11 Adjustment key

After setting the time, you can start and end the cooking by selecting the desired position with temperature button and function button.

i If the current time is not set, time setting will start increasing/moving up from 12:00. Clock icon '9' will be displayed to indicate that the current time has not been set. This icon will disappear once the time is set.

i Current time settings are cancelled in case of power failure and will need to be set again.

Changing the time of the day

In order to change a preset time of the day in your oven;

1. Press key **11** to activate current time icon '9'.

2. Adjust hour of the day using keys **5** and **6**.

Changing screen brightness adjustment

1. Press key **11** to activate screen brightness symbol '7' for screen brightness adjustment.
2. Adjust the desired brightness using keys **5** and **6**.

» Selected brightness level will be displayed as **d-01**, **d-02** or **d-03** on the screen.

First cleaning of the appliance

i The surface may get damaged by some detergents or cleaning materials. Do not use aggressive detergents, cleaning powder/cream or any sharp objects.

1. Remove all packaging materials.
2. Wipe the surfaces of the appliance with a damp cloth or sponge and dry with a cloth.

Initial heating

Heat up the product for about 30 minutes and then switch it off. Thus, any production residues or layers will be burnt off and removed.

⚠ Hot surfaces may cause burns! Do not touch the hot surfaces of the appliance. Use oven gloves. Keep children away from the appliance.

Electric oven

1. Take all baking trays and the wire grill out of the oven.
2. Close the oven door.

3. Select Static position.
4. Select the highest grill power; See *How to use the electric oven, page 18*.
5. Operate the oven about 30 minutes.
6. Turn off your oven; See *How to use the electric oven, page 18*

Grill oven

1. Take all baking trays and the wire grill out of the oven.

2. Close the oven door.
3. Select the highest grill power; see *How to operate the grill, page 25*.
4. Operate the oven about 30 minutes.
5. Turn off your grill; see *How to operate the grill, page 25*



Smell and smoke may emit during first heating. Ensure that the room is well ventilated.

5 How to use the hob

General information on cooking

⚠ Risk of fire by overheated oil!
When you heat oil, do not leave it unattended.

Never try to extinguish the fire with water! When oil has caught fire, immediately cover the pot or pan with a lid. Switch off the hob if safe to do so and phone the fire service.

- Ensure handles of pans cannot accidentally be caught or knocked and do not get hot by adjacent heating zones. Avoid pans that are unstable and easily tipped. Pans that are too heavy to move easily when filled can also be a hazard. Only use flat bottomed pots or pans.
- Use pans which have sufficient capacity for the amount of food being cooked so they don't boil over and cause unnecessary cleaning. Do not place lids on the burners. Always position pans centrally over the burners. When transferring pans from one burner to another always lift the pans do not slide them.

Tips for glass ceramic hobs

- The glass ceramic surface is heat-resistant and insensitive to large temperature deviations.
- Do not use the glass ceramic hob for keeping objects or as cutting surface.

- Use pot and pans with ground bottoms. Sharp edges cause scratches on the surface.
- Do not use aluminium pots and pans. Aluminium damages the glass ceramic surface.

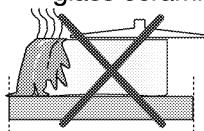

Splashes may damage the ceramic surface and can cause fire.

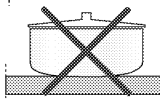

Do not use pots that have concave or convex bottoms.

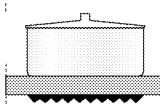

Use pot and pans with smooth bottoms. They ensure a good heat transfer.

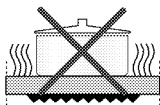

If the pan is too small energy is wasted

How to use hobs

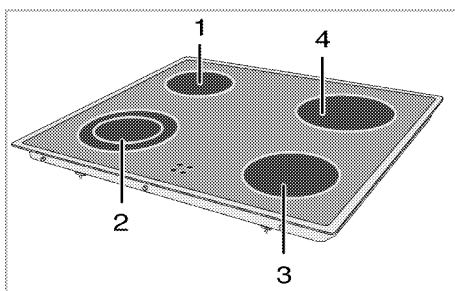

- 1 Single-circuit cooking plate 16-18 cm
 - 2 Dual-circuit cooking plate 21-23/12-14 cm
 - 3 Single-circuit cooking plate 14-16 cm
 - 4 Single-circuit cooking plate 18-20 cm
- is list of advised diameter of pots to be used on related burners.

⚠ Broken glass!

Do not let any objects fall onto the hob. Even small objects (e.g. salt shaker) may damage the hob.

Do not use glass ceramic hobs with cracks. Water may enter into the cracks and cause a short circuit.

If the surface is damaged in any way (e. g. visible cracks), switch off the device immediately to reduce the risk of an electric shock.

i Quick heating glass-ceramic hobs emit a bright light when they are switched on. Do not stare to bright light.

Switching the plate on

The hob control knobs are used for operating the plates. To obtain the desired cooking power, turn the hob control knobs to the corresponding level.

Cooking level	1	2 – 3	4 – 6
	warming	stewing, simmering	cooking, roasting

Cooking level	1	2	3
	warming	stewing, simmering	cooking, roasting

Switching the plate off

Turn hob control knob to off position (top).

How to operate on the multiple zone hotplates

Hobs with multiple region are used for different diameter of pans. It is a standard; the inner zone will be activated when the hob is switched on.

1. By changing the knob position in clockwise direction, the diameter of active zone can be adjusted.
2. While the diameter of active zone changes, there will be a "click" noise.

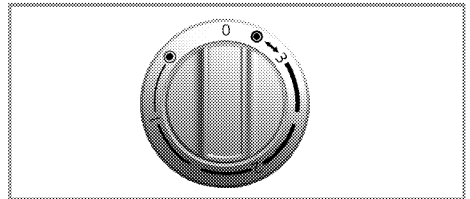

Switch off multiple zone hotplates

1. In order to turn off the hob, set the knob to "0" position by turning it in a counterclockwise direction. Both cooking zones are switched off.

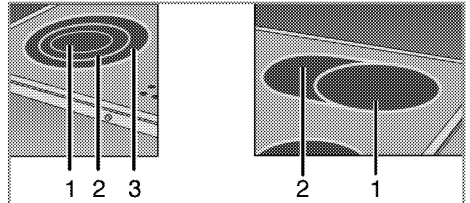

- 1 Stage 1
- 2 Stage 2
- 3 Stage 3

i The 2nd or 3rd zones of multiple zone hotplates will not operate by themselves.

6 How to operate the oven

General information on baking, roasting and grilling

-  Risk of scalding by hot steam!
Take care when opening the oven door as steam may escape.

Tips for baking

- Use non-stick coated appropriate metal plates or aluminum containers or heat-resistant silicone moulds.
- Make best use of the space on the rack.
- It is recommended to place the baking mould in the middle of the rack.
- Select the correct shelf position before turning the oven or grill on - don't move oven shelves when hot.
- Keep the oven door closed.

Tips for roasting

- Seasoning with lemon juice and black pepper will improve the cooking performance when cooking a whole chicken, turkey or a large piece of meat.
- Meat with bones takes about 15 to 30 minutes longer before it is cooked than a roast of the same size without bones.
- You should calculate about 4 to 5 minutes cooking time per centimeter height of the meat.
- Let meat rest in the oven for about 10 minutes after the cooking time. The juice is better distributed all over the roast and does not run out when the meat is cut.

- Fish in a fire-resistant dish should be placed on the rack at the medium or lower level.

Tips for grilling

Grilling is ideal for cooking meat, fish and poultry and will achieve a nice brown surface without it drying out too much. Flat pieces, meat skewers and sausages are particularly suited for grilling as are vegetables with a high water content such as tomatoes and onions.

- Distribute the pieces to be grilled on the wire shelf.
- If the grilling is on the wire shelf, locate a dripping pan under it in order to collect the fat.
- Add some water in the dripping pan for easy cleaning.

How to use the electric oven

-  Before using the oven the clock time must be set. If the clock time is not set, the main oven will not work.

Select temperature and operating mode

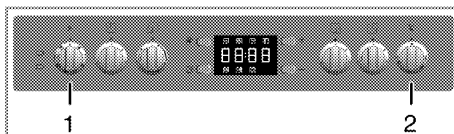

- 1 Function knob
- 2 Thermostat knob

The operating modes of the electric oven are selected with the function knob. The temperature is adjusted with the thermostat knob.

All oven functions are turned off by turning the relevant knob to off (upper) position.

1. Set thermostat knob to the desired temperature.
 2. Set function knob to the required operating mode.
- » The oven heats up to the adjusted temperature and maintains it. During heating, temperature lamp stays on.

Switch off electric oven

Turn function knob and thermostat knob to off position (top).

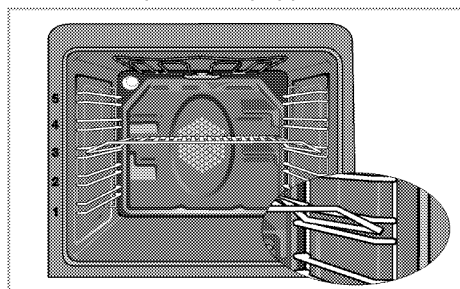

Shelf positions (model dependant)

It is important to position the wire grill on wire shelf correctly. The wire grill must be placed so that it will fit into the opening of the wire shelf as illustrated in the figure.

Operating modes

The order of operating modes shown here might deviate from the arrangement on your appliance.

Top and bottom heat



Top and bottom heat are on. The foodstuffs are heated simultaneously from the upper and lower part. Suitable e.g. for cakes, cookies and casseroles in baking moulds. Cook with one tray only.

Bottom heat



Only bottom heat is on. Is particularly suitable for dishes, such as pizza, which are required to be baked from bottom.

Top and bottom heat with convection air



Top and bottom heat plus fan (in the rear wall) are on. The hot air is distributed evenly and quickly all over the oven by the fan. Cook with one tray only.

Operating with fan



The oven is not heated. Only the fan (in the rear wall) is in operation. Frozen granular food is thawed slowly at room temperature and cooked food is cooled down.

Hot air



The heating ring with fan (in the rear wall) is in operation. The hot air is distributed evenly and quickly all over the oven by the fan. In most cases, preheating is not required. Suitable when several levels are used for the preparation of food. Suitable for cooking with multi trays.

"3D" function



Top heat, bottom heat plus ring heat with fan (in the rear wall) are on. The appliance to be cooked is evenly and quickly cooked all around. Cook with one tray only.

Surface grill



The large grill (under the oven roof) is in operation. Suitable for grilling larger quantities.

- Put big or medium-sized portions in correct shelf position under the grill heater for grilling.
- Set the temperature to maximum level.
- Turn the food after half of the grilling time.

Grill with convection air



The grill effect is not as strong as with normal grilling.

- Put small or medium-sized portions in correct shelf position under the grill heater for grilling.
- Set the temperature to maximum level.
- Turn the food after half of the grilling time.

How to operate the oven timer

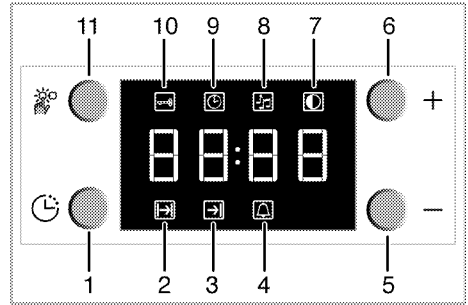

- 1 Program knob
- 2 Cooking time
- 3 Cooking end time
- 4 Alarm period
- 5 Minus key
- 6 Plus key
- 7 Screen brightness adjustment
- 8 Alarm volume
- 9 Current time
- 10 Keylock
- 11 Adjustment key

 The maximum time to be set for the end of the cooking process is 23 hours and 59 minutes. In case of power cut, program will be canceled. Reprogram is needed.

 While making any adjustment, related symbols on the clock will flash. You must wait for a short time for the settings to take effect.

 If semi-automatic or full automatic operation mode is set on the clock, time of the day cannot be adjusted.

-  Cooking time will be displayed once the cooking starts.

Switch on fully automatic operation

In this operation mode you may adjust how long the oven will automatically operate (cooking time) and the time it will be automatically turned off (end of cooking time).

1. Press **1** key to activate cooking time symbol **(2)**.
2. Adjust the cooking time using **5** and **6** keys.

» Cooking symbol will be on (will be displayed continuously) after cooking time is set.

3. For the cooking end time, press **1** key to activate cooking end time symbol **'3'**.

4. Adjust cooking end time using **5** and **6** keys.

» Once the cooking end time is set, cooking end symbol and cooking symbol will be lit (displayed continuously). The end of cooking time symbol **(3)** will disappear as soon as the cooking has started.

5. Place your dish in the oven.

6. Select operation mode and temperature.

» Oven timer automatically calculates the startup time for cooking by using the end of cooking time you have set and the cooking period. Selected operation mode is activated when the startup time of cooking has come and the oven is heated up to the set temperature. It maintains this temperature until the end of the cooking time.

7. After the cooking process is completed, **"End"** symbol will be displayed and the alarm signal will sound.

8. Alarm signal will be on for 2 minutes. To stop the alarm signal, just press any key.

-  If you mute the alarm by pressing any key, the oven will restart operating.

If you press any button at the end of the alarm period, the oven will restart operating.

» Alarm will be silenced and current time will be displayed.

9. **Do not forget** to turn off the oven using temperature knob and function knob.

Switch on semi-automatic operation

In this operation mode, you may adjust the time period during which the oven will operate (cooking time).

1. Press **1** key to activate cooking time symbol **'2'**.

2. Adjust the cooking time using **5** and **6** keys.

» Cooking symbol shall be on (will be displayed continuously) after cooking time is set.

3. Place your dish in the oven.

4. Select operation mode and temperature.

» The oven will be heated up to the preset temperature and will maintain this temperature until the end of the cooking time you selected.

5. After the cooking process is completed, **"End"** symbol will be displayed and the alarm signal will sound.

- Alarm signal will be on for 2 minutes. To stop the alarm signal, just press any key.

i If you mute the alarm by pressing any key, the oven will restart operating.

If you press any button at the end of the alarm period, the oven will restart operating.

- » Alarm will be silenced and current time will be displayed.
- Do not forget to turn off the oven using temperature knob and function knob.

How to use the program lock

Activate the program lock

You can prevent using of clock buttons by activating the program feature.

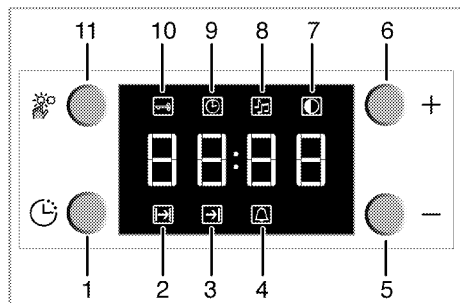

- Program knob
- Cooking time
- Cooking end time
- Alarm period
- Minus key
- Plus key
- Screen brightness adjustment
- Alarm volume
- Current time
- Keylock
- Adjustment key

i When the keylock function is activated, clock buttons except for "11" key cannot be used.

- Press '11' key to activate keylock symbol "10".
 - » "OFF" will be displayed.
- Press 6 key to activate the keylock.
 - » After the keylock has been adjusted, "ON" will be displayed and the keylock symbol will stay on.

Deactivate the program lock

- Press '11' key to activate keylock symbol "10".
 - » "ON" will be displayed.
- Press '5' key to deactivate the keylock.
 - » "OFF" will be displayed after the keylock is turned off.

How to use the alarm clock

In addition to using the timer for cooking, it can be also used as a reminder or an alarm clock.

As soon as the defined period of time has expired, the alarm clock will emit a signal. The alarm clock has no influence on the functions of the oven.

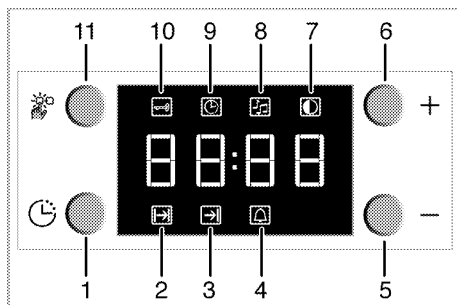

- Program knob
- Cooking time

- 3 Cooking end time
- 4 Alarm period
- 5 Minus key
- 6 Plus key
- 7 Screen brightness adjustment
- 8 Alarm volume
- 9 Current time
- 10 Keylock
- 11 Adjustment key

Setting the alarm clock

1. Press **1** key to activate alarm time symbol (4).
 -  The maximum alarm time can be 23 hours and 59 minutes.
2. Adjust the alarm time using **5** and **6** keys.
 - » Alarm symbol will be on (will be displayed continuously) after alarm time is set, and the alarm time will be displayed.
3. After the alarm time is finished, alarm symbol will start flashing and an alarm signal is heard.

Switching off the alarm

1. To stop the alarm signal, just press any key.
 - » Alarm will be silenced and current time will be displayed.

In order to cancel set alarm time;

1. To reset the alarm time, press **1** key to activate alarm time symbol (4).
2. Press and hold the key **5** until "0.00" is displayed.
 -  Alarm time will be displayed. If the alarm time and cooking time are set concurrently, shortest time will be displayed.

Changing alarm sound adjustment











1. Press '**11**' key to activate alarm sound adjustment symbol (8) for alarm volume adjustment.
2. Adjust the desired sound using '**5**' and '**6**' keys.
 - » Selected alarm sound level will be displayed as "b-01", "b-02" or "b-03" on the screen.



















Cooking times table

-  The values indicated in the table below are data indicative. They may vary according to the type of food as well as your preferences of cooking.

Baking and roasting

-  Level 1 is the **bottom** level in the oven.

Dish	Cooking level number		Rack position	Temperature (°C)	Cooking time (approx. in min.)
Cakes in tray*	One level		4	175	30 ... 35
Cakes in mould*	One level		2	180	40 ... 50
Cakes in cooking paper*	One level		3	175	25 ... 30
	2 levels		1 - 5	175	30 ... 40
	3 levels		1 - 3 - 5	180	45 ... 55
Sponge cake*	One level		3	200	5 ... 10
	2 levels		1 - 5	175	18 ... 25
Cookies*	One level		3	175	20 ... 25
	2 levels		1 - 5	175	25 ... 30
	3 levels		1 - 3 - 5	175	30 ... 40

Dish	Cooking level number		Rack position	Temperature (°C)	Cooking time (approx. in min.)
Dough pastry*	One level		2	200	30 ... 40
	2 levels		1 - 5	200	45 ... 55
	3 levels		1 - 3 - 5	200	55 ... 65
Rich pastry*	One level		2	200	25 ... 35
	2 levels		1 - 5	200	30 ... 40
	3 levels		1 - 3 - 5	190	40 ... 50
Leaven*	One level		2	200	35 ... 45
	2 levels		1 - 3	200	35 ... 45
Lasagna*	One level		2 - 3	200	30 ... 40
Pizza*	One level		2	200 ... 220	15 ... 20
Beef steak (whole) / Roast	One level		3	25 min. 250/max, then 180 ... 190	100 ... 120
Leg of Lamb (casserole)	One level		3	25 min. 250/max, then 190	70 ... 90
Roasted chicken	One level		2	15 min. 250/max, then 180 ... 190	65 ... 70
	One level		2	15 min. 250/max, then 180 ... 190	55 ... 65
Turkey (5.5 kg)	One level		2	25 min. 250/max, then 180 ... 190	150 ... 210
	One level		2	25 min. 250/max, then 180 ... 190	150 ... 210
Fish	One level		3	200	20 ... 30
	One level		3	200	20 ... 30

When cooking with 2 trays at the same time, place the deeper tray on the upper rack and the other one on the lower rack.

* It is suggested to perform preheating for all foods.

In a cooking that requires preheating, preheat at the beginning of cooking until the thermostat lamp turns off.

Tips for baking cake

- If the cake is too dry, increase the temperature some 10 and decrease the cooking time.
- If the cake is wet, use less liquid or lower the temperature by 10°C.
- If the cake is too dark on top, place it on a lower rack, lower the temperature and increase the cooking time.
- If cooked well on the inside but sticky on the outside use less liquid, lower the temperature and increase the cooking time.

Tips for baking pastry

- If the pastry is too dry, increase the temperature some 10 and decrease the cooking time. Dampen the layers of dough with a sauce composed of milk, oil, egg and yoghurt.
- If the pastry takes too long to bake, pay care that the thickness of the pastry you have prepared does not exceed the depth of the tray.
- If the upper side of the pastry gets browned, but the lower part is not cooked, make sure that the amount of sauce you have used for the pastry is not too much at the bottom of the pastry. Try to scatter the sauce equally between

the dough layers and on the top of pastry for an even browning.

-  Cook the pastry in accordance with the mode and temperature given in the cooking table. If the bottom part is still not browned enough, place it on one lower rack next time.

How to operate the grill

-  Before using the oven the clock time must be set. If the clock time is not set, the main oven will not work.

 Hot surfaces may cause burns!
Close oven door during grilling.

Switch on grill

1. Set the function knob onto the grill symbol.
2. Set grill temperature.
3. Preheat for approximately 5 minutes, if it is necessary.

Cooking times table for grilling

Grilling with electric grill

Food	Insertion level	Grilling time (approx.)
Fish	4...5	20...25 min. [#]
Sliced chicken	4...5	25...35 min.
Lamb chops	4...5	20...25 min.
Roast beef	4...5	25...30 min. [#]
Veal chops	4...5	25...30 min. [#]
Toast bread	4	1...2 min.

[#] depending on thickness

Tips for cooking vegetables

- If the vegetable dish runs out of juice and gets too dry, cook it in a pan with a lid instead of a tray. Closed vessels will preserve the juice of the dish.
- If a vegetable dish does not get cooked, boil the vegetables beforehand or prepare them like canned food and put in the oven.

» The thermostat lamp is switched on.

Switch off grill

1. Turn grill control knob to off position (top).



Shelf positions

For optimum grill coverage, position the wire shelf towards the front of the oven just out of contact with the glass door. Placing the wire shelf fully to the rear of the oven will reduce the grill coverage.

7 Maintenance and care

General information

Service life of the product will extend and frequent problems will decrease if the product is cleaned at regular intervals.

-  Risk of electric shock!
Switch off the electricity before cleaning appliance to avoid an electric shock.
-  Hot surfaces may cause burns!
Allow the appliance to cool down before you clean it.
- Clean the product thoroughly after each use. In this way it will be possible to remove cooking residues more easily, thus avoiding these from burning the next time the appliance is used.
- No special cleaning agents are required for cleaning the product. Use warm water with washing liquid, a soft cloth or sponge to clean the product and wipe it with a dry cloth.
- Always ensure any excess liquid is thoroughly wiped off after cleaning and any spillage is immediately wiped dry.
- Do not use cleaning agents that contain acid or chloride to clean the stainless or inox surfaces and the handle. Use a soft cloth with a liquid detergent (not abrasive) to wipe those parts clean, paying attention to sweep in one direction.

 The surface may get damaged by some detergents or cleaning materials.

Do not use aggressive detergents, cleaning powder/cream or any sharp objects.

 Do not use steam cleaners for cleaning.

Cleaning the hob

Glass ceramic surfaces

Wipe the glass ceramic surface using a piece of cloth dampened with cold water in a manner as not to leave any cleaning agent on it. Dry with a soft and dry cloth. Residues may cause damage on the glass ceramic surface when using the hob for the next time.

Dried residues on the glass ceramic surface should under no circumstances be scraped with hook blades, steel wool or similar tools. Remove calcium stains (yellow stains) by a small amount of lime remover such as vinegar or lemon juice. You can also use suitable commercially available products.

If the surface is heavily soiled, apply the cleaning agent on a sponge and wait until it is absorbed well. Then, clean the surface of the hob with a damp cloth.

 Sugar-based foods such as thick cream and syrup must be cleaned promptly without waiting the surface to cool down. Otherwise, glass ceramic surface may be damaged permanently.

Slight color fading may occur on coatings or other surfaces in time. This will not affect operation of the product. Color fading and stains on the glass ceramic surface is a normal condition, and not a defect.

Cleaning the control panel

Clean the control panel and control knobs with a wet cloth and wipe them dry.

- i** Damage of the control panel!
Do not remove the control knobs for control panel cleaning.

Cleaning the oven

No oven cleaner or any other special cleaning agent is required for cleaning the oven. It is recommended to wipe the oven with a damp cloth while it is still warm.

To clean the side wall,

1. Remove the front section of the side rack by pulling it in the opposite direction of the side wall.
2. Remove the side rack completely by pulling it towards you.

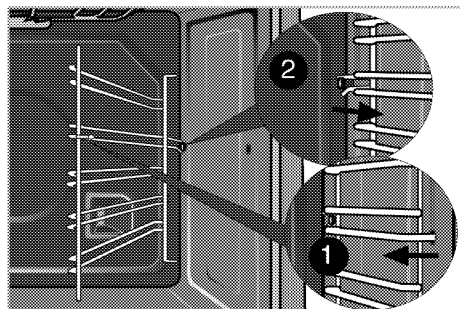

Clean oven door

Don't use any harsh abrasive cleaners or sharp metal scrapers for cleaning the oven door. They could scratch the surface and destroy the glass.

Removal of oven door

1. Open the front door.
2. Open the clips at the hinge housing on the right and left hand sides of the front door by pressing them down as illustrated in the figure.

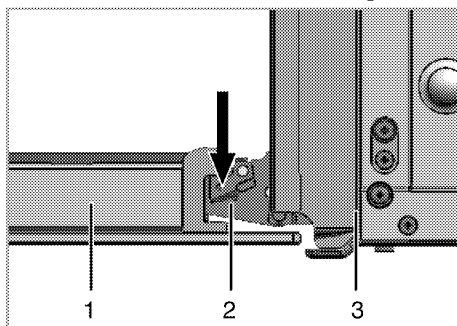

- 1 Front door
- 2 Hinge
- 3 Oven

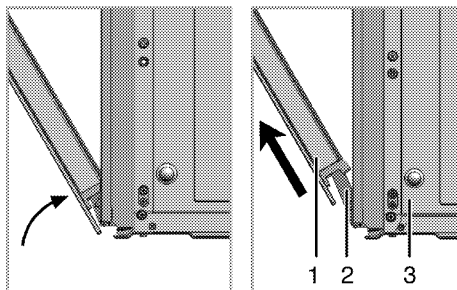

3. Move the front door to half-way.
4. Remove the front door by pulling it upwards to release it from the right and left hinges.

- i** Steps carried out during removing process should be performed in reverse order (steps 4, 3, 2 and 1) to reattach the door. Do not forget to close the clips at the hinge housing when reinstalling the door.

Replacing the oven lamp

 Hot surfaces may cause burns! Make sure that the appliance is switched off and cooled down in order to avoid the risk of an electrical shock.

 The oven lamp is a special electric light bulb that can resist up to 300 °C. See *Technical specifications, page 5* for details. Oven lamps can be obtained from Authorised Service Agents.

 Position of lamp might vary from the figure.

If your oven is equipped with a round lamp:

1. Disconnect the product from mains.
2. Turn the glass cover counter clockwise to remove it.

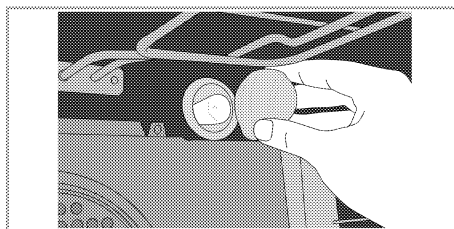

3. Remove the oven lamp by turning it counter clockwise and replace it with the new one.
4. Install the glass cover.

8 Troubleshooting

 Risk of electric shock, short circuit or fire by unprofessional repairs!
Repairs on the appliance must be carried out by an approved service centre.

- It is normal that steam escapes during operation.
- When the metal parts are heated, they may expand and cause noise.

Before you call the service, please check the following points.

Normal operating conditions

- Smoke and smell may emit for a couple of hours during the first operation.

Electrical equipment

Malfunction/problem	Possible cause	Advice/remedy
The appliance does not work.	The mains fuse is defective or has tripped.	Check fuses in the fuse box. If necessary, replace or reset them.
	Timer buttons do not work.	Keylock may be enabled. Please disable it(See; <i>How to use the program lock, page 22</i>).
Oven light does not work	Oven lamp is defective.	Replace oven lamp.
	No current.	Check fuses in the fuse box. If necessary, replace or reset them.
Oven does not heat.	Function knob and/thermostat knob are not set.	Set function knob and thermostat knob.
	If the appliance has a timer, the timer may not be set.	Set the time.
	No power.	Check mains supply and fuse box.

Clock/ timer (If the appliance has a digital timer)

Malfunction/problem	Possible cause	Advice/remedy
Clock display is blinking or clock symbol is on.	Power was interrupted previously.	Set time Then switch the oven off with function knobs, set the oven function again.

If the problem has not been solved:

1. Separate unit from the mains supply (deactivate or unscrew fuse).
2. Call the after-sales service of your store reseller.



Do not attempt to repair the appliance yourself. There are no customer service items inside the appliance.